

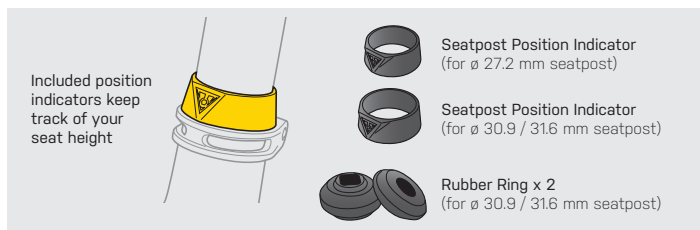

Fits  $\varnothing$  27.2, 30.9 & 31.6 mm ROUND SEATPOST only. Please read the User's Guide before first use.

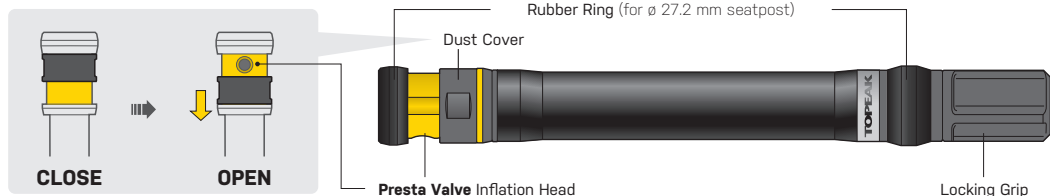

### WARNING

Make sure Ninja P is installed in seatpost properly during a period of time.

Avoid pinching fingers while pumping

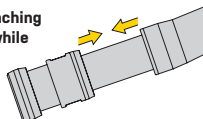

### STORE NINJA P IN SEATPOST

Turn Locking Grip to expand rubber ring for initial fit.

### REMOVE NINJA P FROM SEATPOST

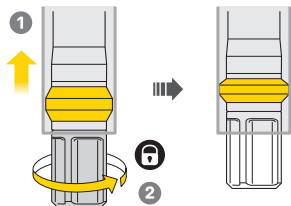

Put the pump into seatpost and turn Locking Grip counter-clockwise to seal the Rubber Ring. (DO NOT insert pump completely into seatpost.)

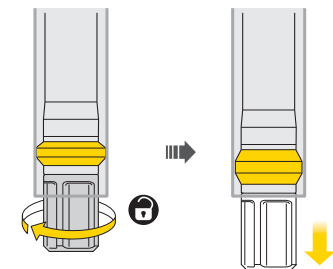

Turn Locking Grip clockwise to loosen the Rubber Ring and remove the pump.

### IMPORTANT NOTE

Recommended NINJA P installation position



If NINJA P is inserted completely, use 5 mm Allen key to remove.

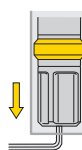

### HOW TO CHANGE RUBBER RING

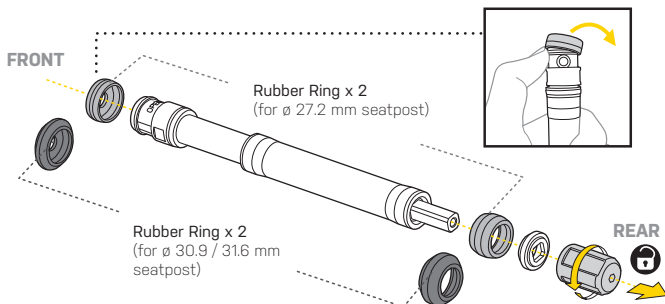

### WARRANTY

2-year Warranty: All mechanical components against manufacturer defects only.

#### Warranty Claim Requirements

To obtain warranty service, you must have your original sales receipt. Items returned without a sales receipt will assume that the warranty begins on the date of manufacture. All warranties will be void if the product is damaged due to user crash, abuse, system alteration, modification, or used in any way not intended as described in this manual.

\* The specifications and design are subject to change without notice.

Please contact your Topeak dealer with any questions. For USA customer service, call: 1-800-250-3068 [www.topeak.com](http://www.topeak.com)